

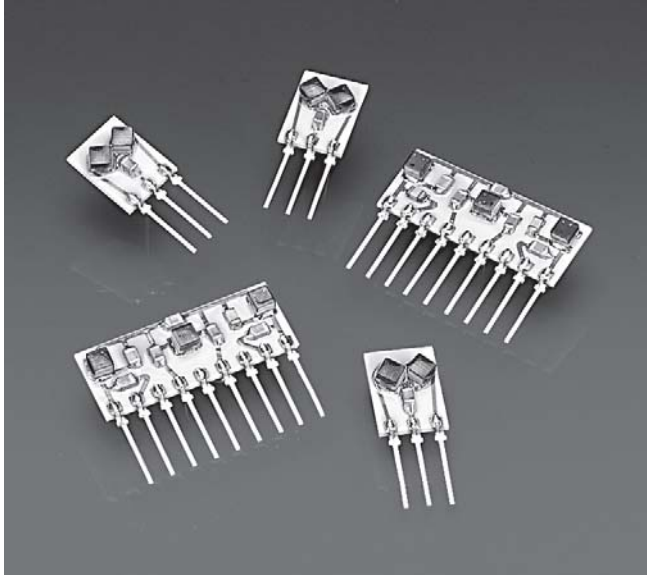

Low Pass LC Filter Modules



Coilcraft's family of low pass LC filters are available in 3rd order Butterworth and 7th order elliptical alignments. These space saving SIP filters offer all the benefits of an LC design: low insertion loss, high power handling and controlled group delay.

Built using Coilcraft's tight tolerance surface mount inductors, these filters can be readily customized to meet your specific requirements.

- 3rd and 7th order alignments
- 50 Ohm characteristic impedance (75 Ohm versions also available)
- Less than 0.3 dB insertion loss

Coilcraft **Designer's Kit D301** contains samples of the filters shown in bold. To order, contact Coilcraft or visit <http://order.coilcraft.com>.

S-Parameter files
ON OUR WEB SITE OR CD

7 Pole Filters

Part number	-3 dB cutoff ¹ (MHz)	I _{rms} ² (mA)
P7LP-304L	0.30	100
P7LP-604L	0.60	200
P7LP-155L	1.5	200
P7LP-305L	3.0	250
P7LP-605L	6.0	250
P7LP-156L	15	300
P7LP-306L	30	400
P7LP-606L	60	500
P7LP-157L	150	600
P7LP-307L	300	600
P7LP-507L	500	600

3 Pole Filters

Part number	-3 dB cutoff ¹ (MHz)	I _{rms} ² (mA)
P3LP-304L	0.30	100
P3LP-604L	0.60	200
P3LP-155L	1.5	200
P3LP-305L	3.0	200
P3LP-605L	6.0	300
P3LP-156L	15	400
P3LP-306L	30	500
P3LP-606L	60	500
P3LP-157L	150	900
P3LP-307L	300	900
P3LP-507L	500	500

1. Tested on Network Analyzers Agilent/HP 8753D Agilent/HP 3577B.
2. Current that causes a 15°C temperature rise from 25°C ambient.
3. **Ambient temperature range:** -40°C to +85°C
4. **Storage temperature range:** Component: -40°C to +85°C
Packaging: -40°C to +80°C
5. Electrical specifications at 25°C.
6. Parts in bold type are included in a Coilcraft Designer's Kit.

Weight: P3LP: 0.33 – 0.68g; P7LP: 0.86 g
Terminations: Matte-tin over nickel over phos bronze
Packaging: 30 per tray

7 Pole Filters

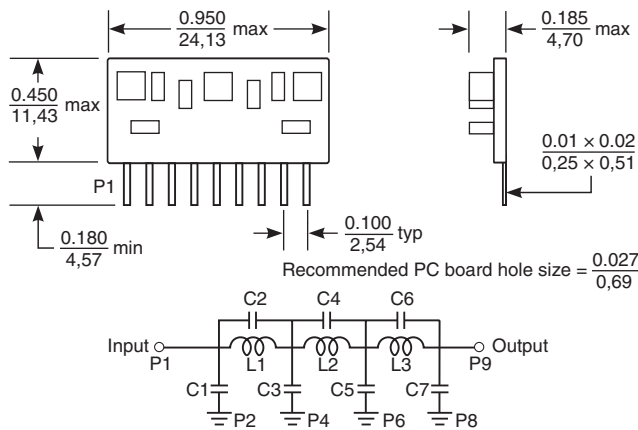

3 Pole Filters

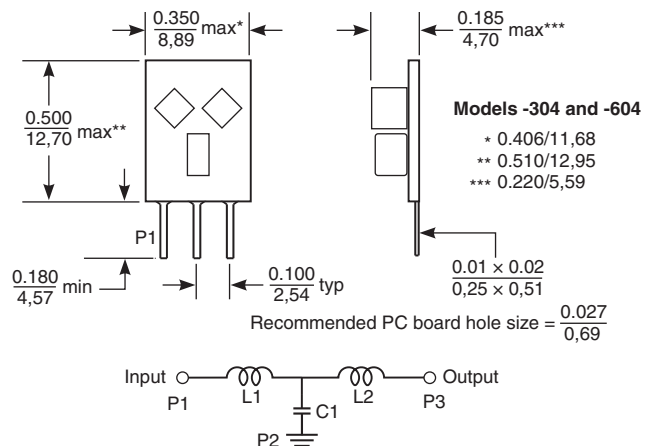

Specifications subject to change without notice.
Please check our website for latest information.

Document 118-1 Revised 10/30/08

1102 Silver Lake Road Cary, Illinois 60013 Phone 847/639-6400 Fax 847/639-1469

E-mail info@coilcraft.com Web <http://www.coilcraft.com>



7 Pole Filters*

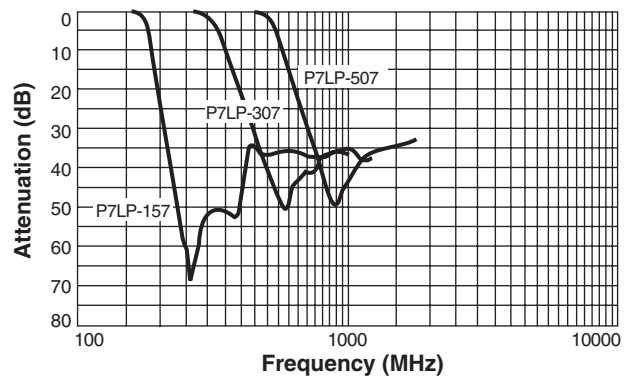
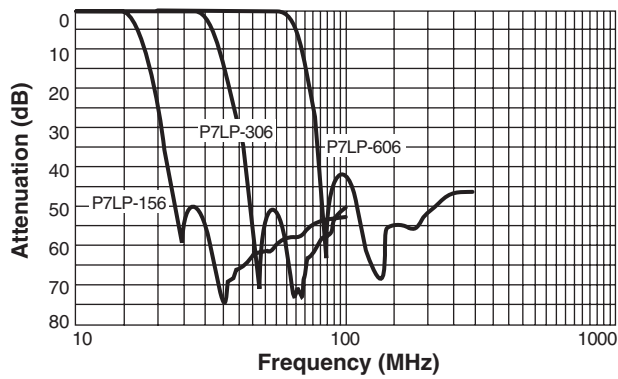
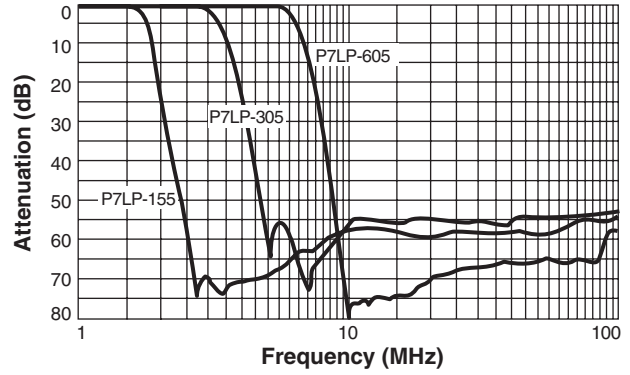
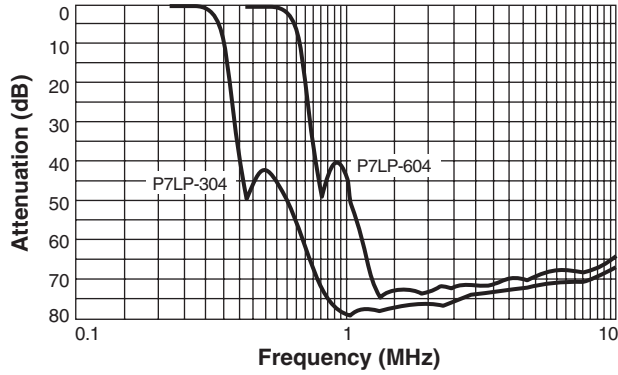

3 Pole Filters*

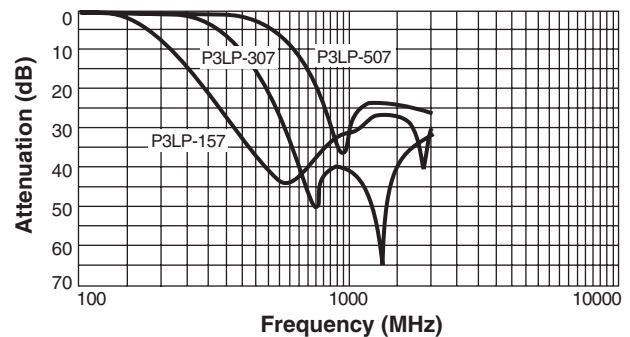
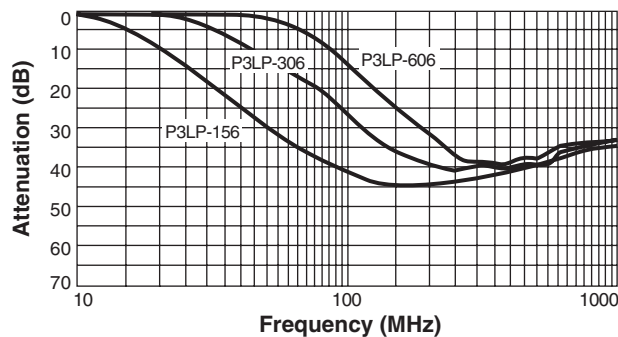
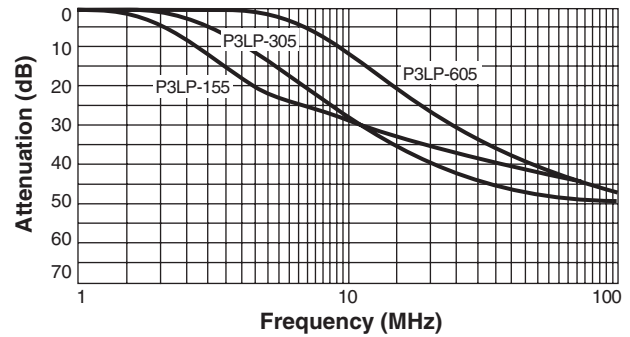
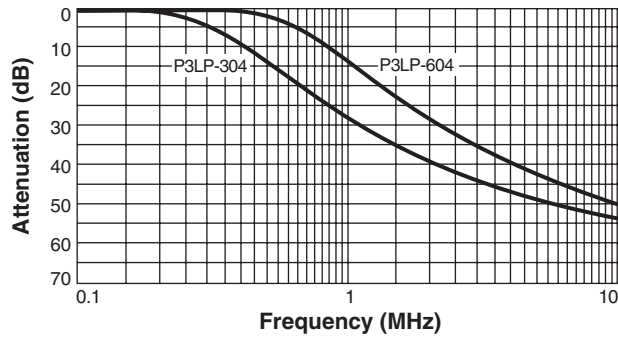

*Measured on Agilent/HP 8753D network analyzer (re: 50Ω)



Specifications subject to change without notice.
Please check our website for latest information.

Document 118-2 Revised 10/30/08

1102 Silver Lake Road Cary, Illinois 60013 Phone 847/639-6400 Fax 847/639-1469

E-mail info@coilcraft.com Web <http://www.coilcraft.com>